

Körnerspitzen

Tailstock centres



■ Inhalt:

- | Mitlaufende Drehbankspitzen
- | Mitlauf. Drehbankspitzen für auswechselbare Einsätze
- | Mitlaufende Zentrierkegel
- | Feste Zentrierspitzen
- | Feste Zentrierkegel
- | Modulare Zentrierkegel und Futterflansche
- | **ROTOR** Rotierende Spitzen
- | Stirnmitnehmer

■ Content:

- | *Revolving tailstock centres*
- | *Revolving tailstock centres for interchangeable inserts*
- | *Revolving tube centres*
- | *Fixed centres*
- | *Fixed tube centres*
- | *Modular tube centres and chuck adaptors*
- | **ROTOR** Live-Centres
- | *Face drivers*

Serie 80 Series 80

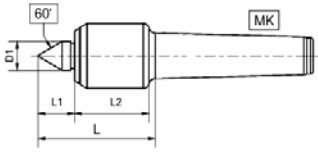

Mitlaufende Präzisions-Drehbankspitze Precision revolving tailstock centre

- stabile Konstruktion
- schaftgelagerter Körner
- kleiner Gehäusedurchmesser
- Dauerschmierung
- Gehäuse gehärtet und geschliffen
- solid design
- centre tip with needle bearings
- slim design with small casing diameter
- maintenance-free lubrication
- housing hardened and ground

Typ / Type	MK / MT	D mm	D1 mm	L mm	L1 mm	L2 mm	Drehzahl / Speed max.	Werkst. / Work piece max. kg	Rundlaufgenauigkeit / Run-out max. mm	Art.-Nr. / Order no.
82	2	32	15	64	19,5	39	6000	200	0,005	● 03-80-02
83	3	34	15	64	19,5	39	6000	400	0,005	● 03-80-03
84	4	43	20	77	27	43	6000	800	0,005	● 03-80-04
85	5	58	30	105	37	59	4000	1200	0,008	● 03-80-05

Serie 80 KOP Series 80 KOP

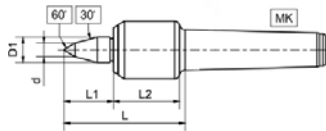

Mitlaufende Präzisions-Drehbankspitze, verlängert Precision revolving tailstock centre, extended

- wie Serie 80, aber mit verlängerter Spitze 30° / 60°
- as series 80, but with extended tip 30° / 60°

Typ / Type	MK / MT	D mm	D1 mm	L mm	L1 mm	L2 mm	d mm	Drehzahl / Speed max.	Werkst. / Work piece max. kg	Rundlaufgenauigkeit / Run-out max. mm	Art.-Nr. / Order no.
82 KOP	2	32	15	74	29	39	8	6000	150	0,005	● 03-80-02KOP
83 KOP	3	34	15	74	29	39	8	6000	300	0,005	● 03-80-03KOP
84 KOP	4	43	20	86	36	43	10	6000	700	0,005	● 03-80-04KOP
85 KOP	5	58	30	116	48	59	12	4000	1000	0,01	● 03-80-05KOP

Serie 100 Series 100

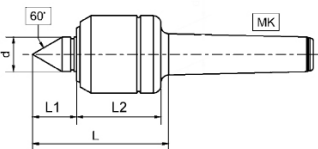

Mitlaufende Präzisions-Drehbankspitze Precision revolving tailstock centre

- Universal-Ausführung mit 3 Rillenkugellagern
- Gehäuse gehärtet und geschliffen
- Körner aus chromlegiertem Werkzeugstahl
- hohe Rundlaufgenauigkeit
- besonders leichter Lauf
- wartungsfreie Dauerschmierung
- universal centre with 3 groove ball bearings
- housing hardened and ground
- centre tip from chromium-alloyed tool steel
- high concentricity
- easy and smooth running
- maintenance-free permanent lubrication

Typ / Type	MK / MT	D mm	d mm	L mm	L1 mm	L2 mm	Drehzahl / Speed max.	Werkst. / Work piece max. kg	Rundlaufgenauigkeit / Run-out max. mm	Art.-Nr. / Order no.
111	1	28	12	57,5	17	34	6500	25	0,005	● 03-111
113	1	35	13	63,5	18	39	5500	50	0,005	● 03-113
121	2	35	13	66	19	39	5500	80	0,005	● 03-121
123	2	45	20	84	26	49	5000	100	0,005	● 03-123
131	3	45	20	84	26	49	5000	150	0,005	● 03-131
133	3	60	24	103	34	60	4000	300	0,005	● 03-133
141	4	60	24	105	34	60	4000	400	0,005	● 03-141
143	4	76	32	126	42	73	3200	650	0,008	● 03-143

- Lagerstandard / in stock
- ▶ innerhalb weniger Tage / within a few days
- auf Anfrage / on request
- * auslaufende Größe / as stock lasts

Serie 100 KOP Series 100 KOP

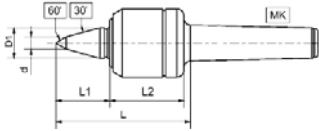

Mitlaufende Präzisions-Drehbankspitze, verlängert Precision revolving tailstock centre, extended

- wie Serie 100, aber mit verlängerter Spitze 30° / 60°
- as series 100, but with extended tip 30° / 60°

Typ / Type	MK / MT	D mm	D1 mm	L mm	L1 mm	L2 mm	d mm	Drehzahl / Speed max.	Werkst. / Work piece max. kg	Rundlaufgenauigkeit / Run-out max. mm	Art.-Nr. / Order no.
123 KOP	2	45	20	94	36	49	8	5000	100	0,005	03-123KOP
131 KOP	3	45	20	94	36	49	8	5000	150	0,005	03-131KOP
133 KOP	3	60	24	110	46	60	10	4000	300	0,005	03-133KOP
141 KOP	4	60	24	117	46	60	10	4000	400	0,005	03-141KOP
143 KOP	4	76	32	139	55	73	12	3200	650	0,008	03-143KOP

Serie 800 Series 800

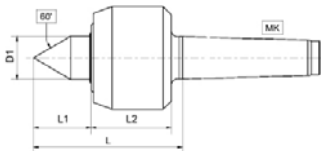

Mitlaufende Präzisions-Drehbankspitze Precision revolving tailstock centre

- schaftgelagerter Körner aus chromlegiertem Werkzeugstahl von hoher Verschleißfestigkeit
- ganzes Gehäuse gehärtet und geschliffen
- mit starkem Längslager und doppelreihigem Schrägkugellager
- hohe Rundlaufgenauigkeit, wartungsfreie Dauerschmierung
- optimale Abdichtung gegen Eindringen von Kühlmittel und Schmutz
- centre tip from chromium-alloyed tool steel with high wear resistance
- housing completely hardened and ground
- with strong axial bearing and double-row angular ball bearings
- high concentricity, maintenance-free permanent lubrication
- optimum sealing to avoid penetration of coolant and dirt

Typ / Type	MK / MT	D mm	D1 mm	L mm	L1 mm	L2 mm	Drehzahl / Speed max.	Werkst. / Work piece max. kg	Rundlaufgenauigkeit / Run-out max. mm	Art.-Nr. / Order no.
823	2	45	20	76	26	43	5000	150	0,005	03-823
831	3	45	20	77	26	43	5000	200	0,005	03-831
833	3	60	24	95	36	52	4300	400	0,005	03-833
841	4	60	24	97	36	52	4300	600	0,005	03-841
843	4	76	32	112	43	60	3200	750	0,005	03-843
851	5	78	32	118	47	60	3200	1800	0,005	03-851
853	5	96	42	134	49	74	2600	2000	0,007	03-853
863	6	110	52	155	62	82	2000	4500	0,01	03-863

Serie 800 KOP Series 800 KOP

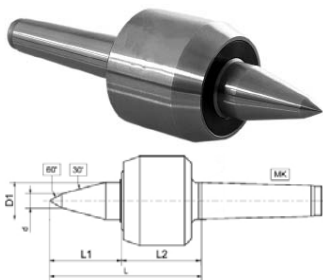

Mitlaufende Präzisions-Drehbankspitze, verlängert Precision revolving tailstock centre, extended

- wie Serie 800, aber mit verlängerter Spitze 30° / 60°
- as series 800, but with extended tip 30° / 60°

Typ / Type	MK / MT	D mm	D1 mm	L mm	L1 mm	L2 mm	d mm	Drehzahl / Speed max.	Werkst. / Work piece max. kg	Rundlaufgenauigkeit / Run-out max. mm	Art.-Nr. / Order no.
823 KOP	2	45	20	87	37	43	8	5000	100	0,005	03-823KOP
831 KOP	3	45	20	88	37	43	8	5000	150	0,005	03-831KOP
833 KOP	3	60	24	106	47	52	10	4300	300	0,005	03-833KOP
841 KOP	4	60	24	107	47	52	10	4300	400	0,005	03-841KOP
843 KOP	4	76	32	130	61	60	12	3200	600	0,005	03-843KOP
851 KOP	5	78	32	132	61	60	12	3200	1200	0,005	03-851KOP
853 KOP	5	96	42	157	71	74	16	2600	1400	0,007	03-853KOP
863 KOP	6	110	52	178	86	82	20	2000	2500	0,01	03-863KOP

Serie 805 Series 805

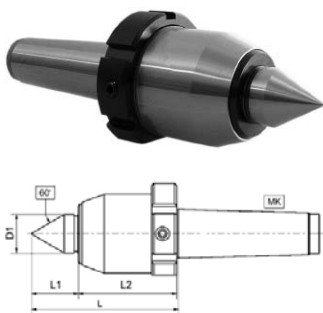

Mitlaufende Hochleistungs-Drehbankspitze High performance revolving tailstock centre

- speziell für NC-Drehmaschinen mit Abdrückmutter
- ganz gehärtet und geschliffen
- Körner schaftgelagert in Präzisions-Nadellager
- für hohe Drehzahlen bei optimalem Rundlauf
- Dauerschmierung
- mit Zusatzdichtung auch für Schleifmaschinen geeignet
- especially developed for use on NC machines with draw-off nut
- completely hardened and ground
- centre tip supported by needle bearings for high speeds with optimum concentricity
- permanent lubrication
- with additional sealing also suitable for grinding machines

Typ / Type	MK / MT	D mm	D1 mm	L mm	L1 mm	L2 mm	Drehzahl / Speed max.	Werkst. / Work piece max. kg	Rundlaufgenauigkeit / Run-out max. mm	G	Art.-Nr. / Order no.
835	3	52	25	94	30	57	12000	300	0,003	M 54 x 1,5	03-835
845	4	60	28	106	35	63	10000	600	0,003	M 62 x 1,5	03-845
855	5	72	35	136	43	82	8000	1200	0,003	M 74 x 1,5	03-855
865	6	83	44	148	50	88	5000	2500	0,007	M 85 x 1,5	03-865

Serie 805 KOP Series 805 KOP



Mitlaufende Hochleistungs-Drehbankspitze, verlängert High performance revolving tailstock centre, extended

- wie Serie 805, aber mit verlängerter Spitze 30° / 60°
- as series 805, but with extended tip 30° / 60°

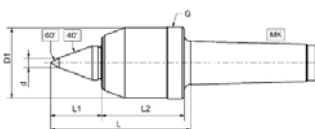

Typ / Type	MK / MT	D mm	D1 mm	L mm	L1 mm	L2 mm	d mm	Drehzahl / Speed max.	Werkst. / Work piece max. kg	Rundlaufgenauigkeit / Run-out max. mm	G	Art.-Nr. / Order no.
835 KOP	3	52	25	104	40	56	8	12000	200	0,003	M 54 x 1,5	03-835KOP
845 KOP	4	60	28	115	45	63	8	10000	400	0,003	M 62 x 1,5	03-845KOP
855 KOP	5	72	35	146	53	82	10	8000	800	0,003	M 74 x 1,5	03-855KOP
865 KOP	6	83	44	171	67	88	14	5000	1700	0,007	M 85 x 1,5	03-865KOP

Serie 1605 Series 1605



Mitlaufende Hochleistungs-Drehbankspitze Heavy-duty NC revolving tailstock centre

- mit Abdrückmutter
- Erhältlich in 2 Varianten:
Standard oder mit Hartmetalleinsatz
- with draw-off nut
- available in 2 versions:
standard or with carbide tip

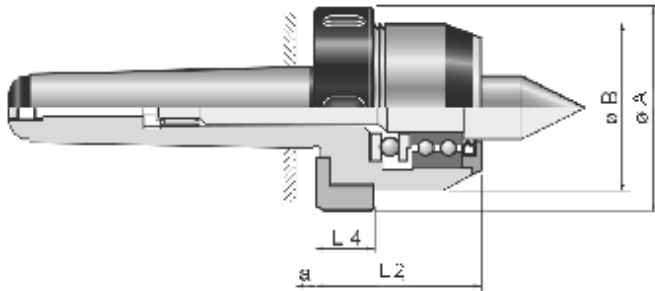

MK / MT	A mm	B mm	L1 mm	L2 mm	Drehzahl / Speed max.	Rundlaufgenauigkeit / Run-out max. mm	kg
3	69	55	49	22	7000	0,005	1,1
4	74	61	57	24	5500	0,005	1,9
5	92	80	65	24	4500	0,005	3,9
6	104	93	75	27	3200	0,008	8,8

Standard Standard

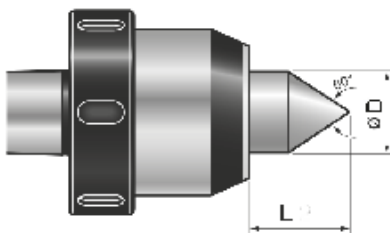

MK / MT	D mm	L mm	Art.-Nr. / Order no.
3	22	28	▶ 03-1603
4	29	40	▶ 03-1604
5	38	48	▶ 03-1605
6	42	55	▶ 03-1606

Mit Hartmetallspitze Carbide tip

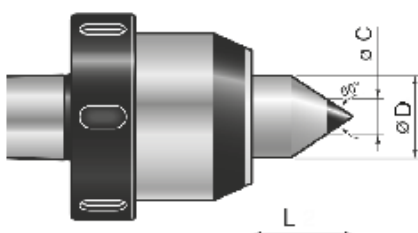

MK / MT	D mm	C mm	L mm	Art.-Nr. / Order no.
3	22	10	28	▶ 03-1603HM
4	29	12	40	▶ 03-1604HM
5	38	18	48	▶ 03-1605HM
6	42	20	55	▶ 03-1606HM

Serie 900 Series 900

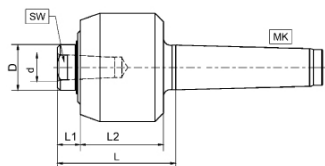

Mitlaufende Präzisions-Drehbankspitze für Wechseleinsätze Precision revolving tailstock centre for interchangeable inserts

- gleiche Konstruktion wie Reihe 800, jedoch für auswechselbare Einsätze (siehe Seiten 118 - 120)
- Lieferung ohne Einsätze
- komplette Sätze siehe Seite 120
- same construction as series 800, but for interchangeable inserts (see pages 118 - 120)
- delivered without inserts
- complete boxed sets see page 120

MK / MT	Typ / Type	D mm	D1 mm	d mm	L mm	L1 mm	L2 mm	SW	Drehzahl / Speed max.	Werkst. / Work piece max. kg	Rundlaufgenauigkeit / Run-out max. mm	Art.-Nr. / Order no.
2	923	45	20	12	59	10	43	17	5000	50	0,005	● 03-923
3	933	60	24	14	68	12	50	19	4300	200	0,005	● 03-933
4	943	76	32	18	79	13	58	27	3200	300	0,007	● 03-943
5	953	96	42	24	98	14	72	36	2600	800	0,01	● 03-953

Auswechselbare Einsätze für Serie 900 Interchangeable inserts for series 900

5

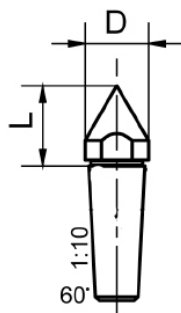

Kegelgröße / Taper ratio 1:10

Spitzkörner Pointed centre

Zu Typ / For type	D mm	L mm	Art.-Nr. / Order no.
923 / 935	14	20	● 03-923/1
933 / 945	16	21	● 03-933/1
943 / 955	22	27	● 03-943/1
953 / 965	28	34	● 03-953/1

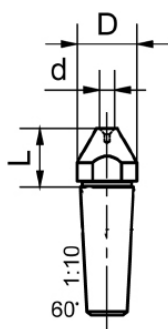

Kegelgröße / Taper ratio 1:10

Hohlkörner Hollow centre

Zu Typ / For type	D mm	d mm	L mm	Art.-Nr. / Order no.
923 / 935	14	4	15	● 03-923/2
933 / 945	16	4	17	● 03-933/2
943 / 955	22	5	21	● 03-943/2
953 / 965	28	6	27	● 03-953/2

Auswechselbare Einsätze für Serie 900

Interchangeable inserts for series 900

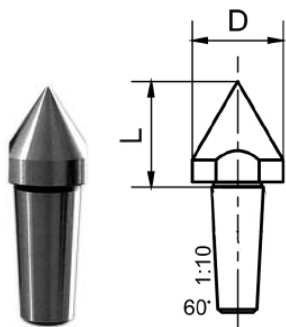

Kegelgröße / Taper ratio 1:10

Großer Spitzkörner

Large pointed centre

Zu Typ / For type	D mm	L mm	Art.-Nr. / Order no.
923 / 935	17	23	03-923/3
933 / 945	25	31	03-933/3
943 / 955	32	40	03-943/3
953 / 965	38	45	03-953/3

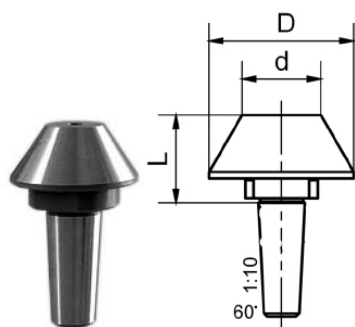

Kegelgröße / Taper ratio 1:10

Kegel

Taper

Zu Typ / For type	D mm	d mm	L mm	Art.-Nr. / Order no.
923 / 935	28	13	33	03-923/4
933 / 945	44	24	28	03-933/4
943 / 955	55	30	34	03-943/4
953 / 965	68	36	41	03-953/4

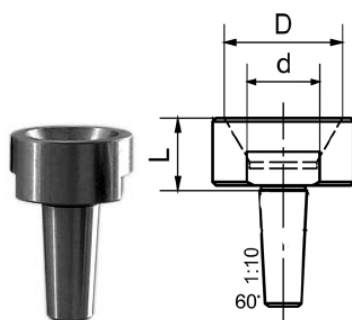

Kegelgröße / Taper ratio 1:10

Hohlkegel

Female taper

Zu Typ / For type	D mm	d mm	L mm	Art.-Nr. / Order no.
923 / 935	20	10	17	03-923/5
933 / 945	35	20	23	03-933/5
943 / 955	42	25	28	03-943/5
953 / 965	60	37	35	03-953/5

Auswechselbare Einsätze für Serie 900

Interchangeable inserts for series 900

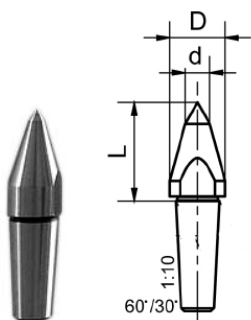

Kegeelgröße / Taper ratio 1:10

Kopierkörner

Copying centre

Zu Typ / For type	D mm	d mm	L mm	Art.-Nr. / Order no.
923 / 935	14	4	32	● 03-923/6
933 / 945	18	8	35	● 03-933/6
943 / 955	22	8	43	● 03-943/6
953 / 965	28	10	52	● 03-953/6



Satz im Kasten

Set in a box

Typ / Type	MK / MT	Art.-Nr. / Order no.
923	2	● 03-923K
933	3	● 03-933K
943	4	● 03-943K
953	5	● 03-953K

Serie 400

Series 400

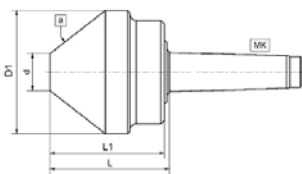

Mitlaufende Präzisions-Zentrierkegel

Precision revolving tube centre

- zur Bearbeitung von Rohren und anderen Hohlkörpern
 - ganzes Werkzeug gehärtet und fein geschliffen
 - stabile Konstruktion
 - wartungsfreie Dauerschmierung
 - abgedichtet
 - auch für Schleifarbeiten geeignet
- for machining of tubes and other hollow objects
 - completely hardened and fine-ground
 - time-tested and sturdy design
 - maintenance-free permanent lubrication
 - sealed
 - also suitable for grinding operations

Typ / Type	MK / MT	D1 mm	D mm	L mm	L1 mm	Winkel / Angle	Drehzahl / Speed max.	Werkst. / Work piece max. kg	Rundlauf- genauigkeit / Run-out max. mm	kg	Art.-Nr. / Order no.
421	2	60	20	73	66	60°	4000	200	0,005	1	● 03-421
431	3	80	30	86	78	60°	3500	450	0,005	2	● 03-431
432	3	100	30	100	92	75°	3000	400	0,005	4	● 03-432
441	4	100	30	101	92	75°	3000	650	0,005	4	● 03-441
442	4	125	50	91	82	75°	3000	650	0,007	5	● 03-442
451	5	125	50	92	82	75°	3000	1800	0,007	6	● 03-451
452	5	150	50	112	102	75°	2800	1900	0,007	9	● 03-452
461	6	150	50	112	102	75°	2800	2800	0,01	12	● 03-461
453	5	200	50	136	126	75°	1800	2000	0,01	15	● 03-453
462	6	200	50	136	126	75°	1800	2800	0,01	18	● 03-462

- Lagerstandard / in stock
- ▶ innerhalb weniger Tage / within a few days
- auf Anfrage / on request
- * auslaufende Größe / as stock lasts

Mitlaufende Drehbankspitzen BASIC

Revolving tailstock centres BASIC

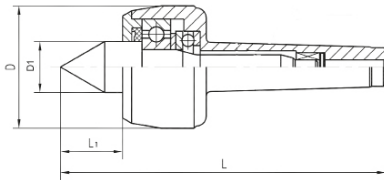
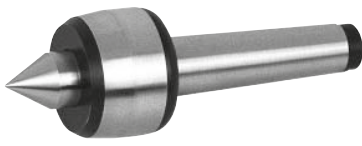

Mitlaufende Drehbankspitzen

Revolving tailstock centre

MK / MT	D mm	L mm	L1 mm	D1 mm	Winkel / Angle	Drehzahl / Speed max.	Werkst. / Work piece max. kg	Art.-Nr. / Order no.
1	36	114	17	15	60°	7000	100	13-MLK-01
2	45	129	24	20	60°	7000	200	13-MLK-02
3	60	160,5	31	25	60°	5000	500	13-MLK-03
4	70	205	41	32	60°	3800	800	13-MLK-04
5	90	258,5	50,5	40	60°	3000	2000	13-MLK-05
6	105	334	57,5	50	60°	2600	3500	13-MLK-06

Mitlaufende Drehbankspitzen, verlängert

Revolving tailstock centre, extended

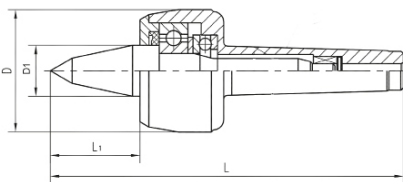

- mit verlängerter Spitze 30° / 60° - with extended tip 30° / 60°

MK / MT	D mm	L mm	L1 mm	D1 mm	Winkel / Angle	Drehzahl / Speed max.	Werkst. / Work piece max. kg	Art.-Nr. / Order no.
2	45	139	34	20	30°/60°	7000	140	13-MLK-02KOP
3	60	176,5	47	25	30°/60°	5000	400	13-MLK-03KOP
4	70	217	53	32	30°/60°	3800	500	13-MLK-04KOP
5	90	273	65	40	30°/60°	3000	1200	13-MLK-05KOP
6	105	354,5	78	50	30°/60°	2600	2500	13-MLK-06KOP

Mitlaufende Drehbankspitzen, schlanke Ausführung, 60°

Revolving tailstock centre, slim design, 60°

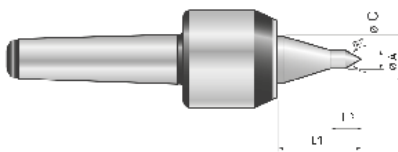

MK / MT	D1 mm	C mm	L1 mm	L2 mm	Winkel / Angle	Drehzahl / Speed max.	Werkst. / Work piece max. kg	Art.-Nr. / Order no.
1	16	6	25	9	60°	8500	140	03-SKP-1
2	22	8	32	11	60°	6000	400	03-SKP-2
3	22	10	42	15	60°	5000	500	03-SKP-3HS
4	29	12	51	16	60°	4000	1200	03-SKP-4HS
5	38	16	56	18	60°	3000	2500	03-SKP-5HS
6	42	18	78	20	60°	2500	2500	03-SKP-6HS

Mitlaufender Zentrierkegel BASIC

Revolving tube centres BASIC



Mitlaufender Zentrierkegel

Revolving tube centre

- gehärtet und geschliffen

- hardened and ground

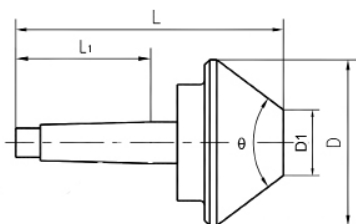

MK / MT	D mm	D1 mm	L mm	L1 mm	Winkel / Angle	Drehzahl / Speed max.	Werkst. / Work piece max. kg	Art.-Nr. / Order no.
2	60	20	132	64	60°	4000	200	13-MLZK-2/60
3	100	30	170	81	60°	3000	600	13-MLZK-3/100
4	160	40	232	102,5	60°	1900	800	13-MLZK-4/160
5	200	40	252	129,5	75°	1500	1600	13-MLZK-5/200
5	250	57	281	129,5	75°	1300	1800	13-MLZK-5/250
6	250	57	355	182	75°	1200	2000	13-MLZK-6/250

Feste Zentrierkegel BASIC

Fixed tube centre BASIC

Zentrierkegel, fest

Fixed tube centre

- gehärtet und geschliffen
- Rundlaufgenauigkeit: 0,003 mm
- *hardened and ground*
- *max. runout: 0,003 mm*

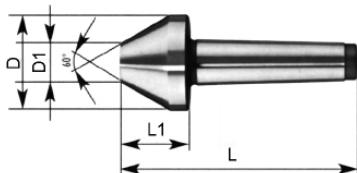

MK / MT	D mm	D1 mm	L1 mm	L mm	Art.-Nr. / Order no.
2	50	10	40	110	03-ZK-2-50
3	50	20	35	123	03-ZK-3-50
3	90	40	55	143	03-ZK-3-90
4	50	20	35	146	03-ZK-4-50
4	90	40	55	166	03-ZK-4-90
5	90	40	55	195	03-ZK-5-90
5	130	50	80	220	03-ZK-5-130

Zentrierkegel mit Abdrückgewinde, fest

Fixed tube centre with draw-off thread

- Lieferung ohne Abdrückmutter
- gehärtet und geschliffen
- Rundlaufgenauigkeit: 0,003 mm
- *supplied without draw-off nut*
- *hardened and ground*
- *max. runout: 0,003 mm*

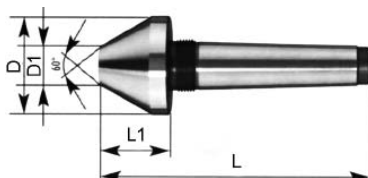

MK / MT	Gewinde / Thread mm	D mm	D1 mm	L1 mm	L mm	Art.-Nr. / Order no.
2	M22 x 1,5	50	10	40	122	03-ZKA-2-50
3	M27 x 1,5	50	20	35	136	03-ZKA-3-50
3	M27 x 1,5	90	40	55	156	03-ZKA-3-90
4	M36 x 1,5	50	20	35	162	03-ZKA-4-50
4	M36 x 1,5	90	40	55	182	03-ZKA-4-90
5	M48 x 1,5	90	40	55	211	03-ZKA-5-90
5	M48 x 1,5	130	50	80	236	03-ZKA-5-130

Abdrückmutter

Draw-off nut



MK / MT	Gewinde / Thread mm	Art.-Nr. / Order no.
1	M16 x 1,5	03-ADM-1
2	M22 x 1,5	03-ADM-2
3	M27 x 1,5	03-ADM-3
4	M36 x 1,5	03-ADM-4
5	M48 x 1,5	03-ADM-5
6	M68 x 1,5	03-ADM-6

Modulare Zentrierkegel und Futterflansche Modular tube centres and chuck adaptors

Grundkörper mitlaufend, Typ MGK Revolving base body, type MGK

- für Zentrierkegelköpfe Typ ZKK und Futterflansche Typ FFL
- for tube centres type ZKK and chuck adaptors type FFL

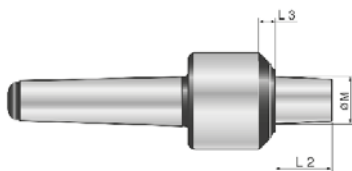

MK / MT	M mm	L2 mm	L3 mm	Art.-Nr. / Order no.
3	35	43	5	▶ 13-MGK-MK3
4	35	43	5	▶ 13-MGK-MK4
5	35	43	5	▶ 13-MGK-MK5
6	35	43	5	▶ 13-MGK-MK6
M80	35	44	6	▶ 13-MGK-M80

Grundkörper fest, Typ FGK Fixed base body, type FGK

- für Zentrierkegelköpfe Typ ZKK und Futterflansche Typ FFL
- for tube centres type ZKK and chuck adaptors type FFL

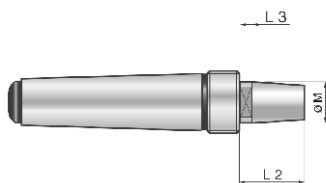

MK / MT	M mm	L2 mm	L3 mm	Art.-Nr. / Order no.
3	35	55	17	▶ 13-FGK-MK3
4	35	55	17	▶ 13-FGK-MK4
5	35	55	17	▶ 13-FGK-MK5
6	35	55	17	▶ 13-FGK-MK6

Zentrierkegelkopf, Typ ZKK Tube centre, type ZKK

- für die Bearbeitung von Rohren oder Hohlköpern von Ø 45 mm bis 600 mm
- for machining of pipes and hollow bodies from Ø 45 mm to Ø 600 mm
- für Grundkörper Typ MGK / FGK
- for base body type MGK / FGK

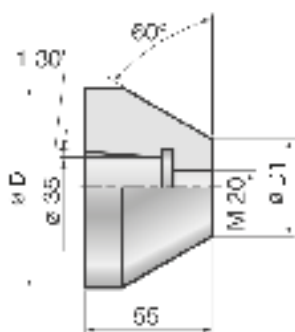

D1 mm	D mm	kg	Art.-Nr. / Order no.
45	98	1,6	▶ 13-ZKK-98
95	148	3,9	▶ 13-ZKK-148
145	198	7,1	▶ 13-ZKK-198
195	248	10,7	▶ 13-ZKK-248
245	298	15,0	▶ 13-ZKK-298
295	348	21,0	▶ 13-ZKK-348
345	398	20,0	▶ 13-ZKK-398
395	448	29,0	▶ 13-ZKK-448
445	498	34,0	▶ 13-ZKK-498
495	545	32,0	▶ 13-ZKK-545
545	600	36,0	▶ 13-ZKK-600

Abdrückschraube für Zentrierkegel Extraction screw for tailstock centre

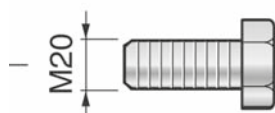

Gewinde / Thread	Art.-Nr. / Order no.
M20	▶ 13-ZKK-AS

- Lagerstandard / in stock
- ▶ innerhalb weniger Tage / within a few days
- auf Anfrage / on request
- * auslaufende Größe / as stock lasts



Modulare Zentrierkegel und Futterflansche

Modular tube centres and chuck adaptors

Futterflansch, Typ FFL Chuck adaptor, type FFL

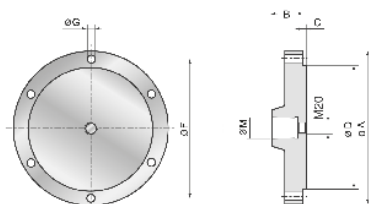

- zur Aufnahme von Drehfuttern nach DIN 6350
- für Grundkörper Typ MGK / FGK

- for mounting of chucks according to DIN 6350
- for base body type MGK / FGK

A mm	M mm	F mm	G mm	B mm	C mm	D mm	Art.-Nr. / Order no.
100	35	83	6,5	52,2	4,5	70	▶ 13-FFL-100
160	35	140	11	51,5	4,5	125	▶ 13-FFL-160
200	35	176	11	50,5	4,5	160	▶ 13-FFL-200
250	35	224	13	50,5	4,5	200	▶ 13-FFL-250

Typ DA, mit Druckanzeige und großem Federweg
Type DA, with pressure indication and long travel stroke

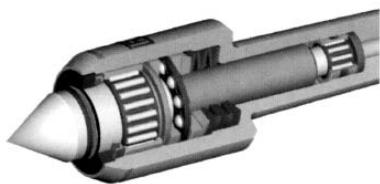

Anwendungsbereich:

Die Druckanzeige durch Farbringe ermöglicht eine schnelle Einstellung und Überwachung des optimalen Anstell-druckes. Bei fester Positionierung werden Längentoleranzen und unterschiedliche Zentrierbohrungen durch den Federweg kompensiert. Leichte Werkstücke können entsprechend fein gespannt werden.

Application:

A pressure indicator with different color bands permits rapid settings and monitoring of the optimum pressure. Length tolerances and different centre bores are compensated through a travel stroke at fixed positions. Thus light work pieces can be clamped very carefully.

Federkraft für allgemeines Drehen
Spring load for regular lathe

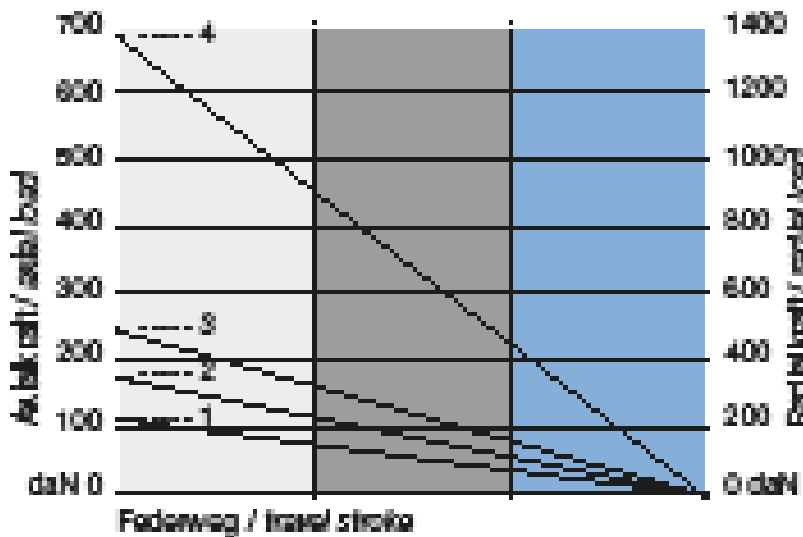

Ausführung / Model	Diagramm / Diagram
MK / MT 2	1
MK / MT 3	2
MK / MT 4	3
MK / MT 5	4
Zyl. / cyl. Ø20 x 40	1
Zyl. / cyl. Ø25 x 50	2
Zyl. / cyl. Ø1" x 2"	2
Zyl. / cyl. Ø32 x 63	3
VDI 20	1
VDI 30	2
VDI 40	3
VDI 50	4

Typ DA-N, normale Spitze, allgemeines Drehen
Type DA-N, regular tip, regular turning

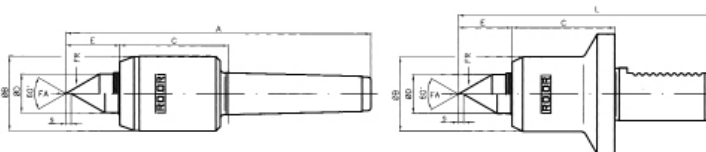

Ausführung / Model	FA daN	FR daN	L mm	B mm	C mm	D mm	E mm	s mm	Werkstück / Work piece max. kg	Drehzahl / Speed max.	Art.-Nr. / Order no.
MK / MT 2	11-110	24-240	136	34	53	14	19	2,7	190	7000	▶ 03-0241
MK / MT 3	20-200	40-420	173	42	62	22	31	3	440	5800	▶ 03-0341
MK / MT 4	23-230	50-500	209	53	72	28	33	4,3	900	4800	▶ 03-0441
MK / MT 5	80-800	150-1500	259	64	88	38	42	5,2	1850	4000	▶ 03-0541
Zyl. / cyl. Ø25 x 50	20-200	40-420	139	42	58	22	31	3	190	5800	▶ 03-2551
Zyl. / cyl. Ø1" x 2"	20-190	40-420	139	42	58	22	31	3	440	5800	▶ 03-0151
Zyl. / cyl. Ø32 x 63	23-230	50-500	165	53	68	28	33	4,3	900	4800	▶ 03-3251
VDI 20	11-110	24-240	108	34	48	14	19	2,7	190	7000	▶ 03-2061
VDI 30	20-200	40-420	144	42	58	22	31	3	440	5800	▶ 03-3061
VDI 40	23-230	50-500	165	53	68	28	33	4,3	900	4800	▶ 03-4061
VDI 50	80-800	150-1500	201	64	81	38	42	5,2	1850	4000	▶ 03-5061



Typ DA-V, verlängerte Spitze, allgemeines Drehen
Type DA-V, extended tip, regular turning

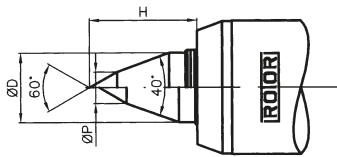

Ausführung / Model	D mm	H mm	P mm	Art.-Nr. / Order no.
MK / MT 2	15	22	8	03-0242
MK / MT 3	22	35	10	03-0342
MK / MT 4	28	41	14	03-0442
MK / MT 5	38	51	15	03-0542
Zyl. / cyl. Ø25 x 50	22	35	10	03-2552
Zyl. / cyl. Ø1" x 2"	22	35	10	03-0152
Zyl. / cyl. Ø32 x 63	28	41	14	03-3252
VDI 20	14	22	8	03-2062
VDI 30	22	35	10	03-3062
VDI 40	28	41	14	03-4062
VDI 50	38	51	15	03-5062

Typ DA-L, schlanke Spitze, allgemeines Drehen
Type DA-L, slim tip, regular turning

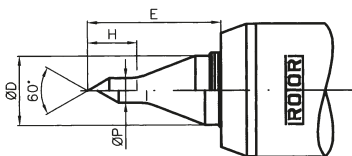

Ausführung / Model	D mm	E mm	H mm	P mm	Art.-Nr. / Order no.
MK / MT 2	14	28	12	5,8	03-0248
MK / MT 3	22	43	16	7,8	03-0348
MK / MT 4	28	51	19	9,8	03-0448
MK / MT 5	38	62	22	11,8	03-0548
Zyl. / cyl. Ø25 x 50	22	43	16	7,8	03-2558
Zyl. / cyl. Ø1" x 2"	22	43	16	7,8	03-0158
Zyl. / cyl. Ø32 x 63	28	51	19	9,8	03-3258
VDI 20	14	28	12	5,8	03-2068
VDI 30	22	43	16	7,8	03-3068
VDI 40	28	51	19	9,8	03-4068
VDI 50	38	62	22	11,8	03-5068

Typ E-B, Vollkegel 60°
Type E-B, pipe nose 60°

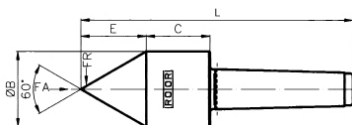

Ausf. / Model	MK / MT	L mm	B mm	C mm	E mm	Werkst. / Work pc. max. kg	FR max. daN	FA max. daN	Rundlaufabw. / Max. runout	Drehzahl / Speed max.	Art.-Nr. / Order no.
ST	2	132	38	30	33	180	90	90	0,002	13500	03-2110
SU	2	143	45	35	39	260	130	115	0,002	11000	03-2210
ST	3	160	45	35	39	260	130	115	0,002	11000	03-3110
SU	3	184	55	50	48	440	220	260	0,002	8500	03-3210
ST	4	206	55	50	48	440	220	260	0,002	8500	03-4110
SU	4	255	70	57	61	670	335	440	0,002	6700	03-4210
ST	5	253	70	57	61	670	335	440	0,002	6700	03-5110
SU	5	275	80	70	69	950	475	925	0,004	5300	03-5210
ST	6	329	80	70	69	950	475	925	0,004	5300	03-6110

Feste Zentrierspitzen Serie 500

Fixed centres series 500

Feststehende Präzisions-Zentrierspitzen nach DIN 806+807

Fixed centres according to DIN 806+807

- ganz gehärtet und geschliffen
- completely hardened and ground

Typ 501 DIN 806 WS

Type 501 DIN 806 WS



Standard
Standard

Typ / Type	MK / MT	D mm	L mm	Winkel / Angle	Art.-Nr. / Order no.
511	1	12,2	80	60°	● 03-511
521	2	18	100	60°	● 03-521
531	3	24,1	125	60°	● 03-531
541	4	31,6	160	60°	● 03-541
551	5	44,7	200	60°	● 03-551
561	6	63,8	270	60°	● 03-561

Typ 503 DIN 806 E

Type 503 DIN 806 E

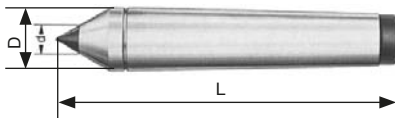

Hartmetalleinsatz
Full carbide tip

Typ / Type	MK / MT	D mm	L mm	Winkel / Angle	d mm	Art.-Nr. / Order no.
513	1	12,2	80	60°	7	● 03-513
523	2	18	100	60°	7	● 03-523
533	3	24,1	125	60°	11	● 03-533
543	4	31,6	160	60°	14	● 03-543
553	5	44,7	200	60°	18	● 03-553
563	6	63,8	270	60°	18	● 03-563

Typ 504 DIN 806 HE

Type 504 DIN 806 HE

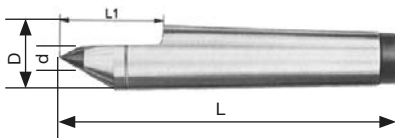

Hartmetalleinsatz mit halber Spitze
Half carbide tip

Typ / Type	MK / MT	D mm	L mm	Winkel / Angle	d mm	L1 mm	Art.-Nr. / Order no.
514	1	12,2	80	60°	7	22	● 03-514
524	2	18	100	60°	7	30	● 03-524
534	3	24,1	125	60°	11	38	● 03-534
544	4	31,6	160	60°	14	50	● 03-544
554	5	44,7	200	60°	18	63	● 03-554
564	6	63,8	270	60°	18	79	* 03-564

Typ 504 DIN 806 HE - verlängert

Type 504 DIN 806 HE - extended

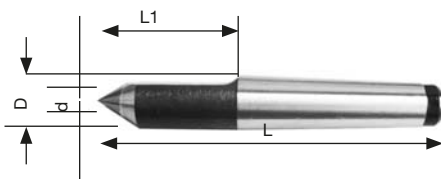

Hartmetalleinsatz mit verlängerter halber Spitze
Extended half carbide tip

Typ / Type	MK / MT	D mm	L mm	Winkel / Angle	d mm	L1 mm	Art.-Nr. / Order no.
524VL	2	18	135	60°	11	65	● 03-524VL
534VL	3	24,1	150	60°	14	63	● 03-534VL
544VL	4	31,6	180	60°	18	70	● 03-544VL

- Lagerstandard / in stock
- ▶ innerhalb weniger Tage / within a few days
- auf Anfrage / on request
- * auslaufende Größe / as stock lasts

Feste Zentrierspitzen Serie 500

Fixed centres series 500

Typ 505 DIN 807 WS

Type 505 DIN 807 WS

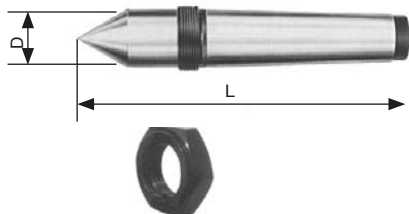

Mit Abdrückmutter
With draw-off nut

Typ / Type	MK / MT	D mm	L mm	Winkel / Angle	G mm	Art.-Nr. / Order no.
525	2	18	100	60°	M22x1,5	● 03-525
535	3	24,1	125	60°	M27x1,5	● 03-535
545	4	31,6	160	60°	M36x1,5	● 03-545
555	5	44,7	200	60°	M48x1,5	● 03-555
565	6	63,8	270	60°	M68x1,5	● 03-565

Typ 506 DIN 807 E

Type 506 DIN 807 E



Hartmetalleinsatz mit Abdrückgewinde
Full carbide tip with thread

Typ / Type	MK / MT	D mm	L mm	Winkel / Angle	d mm	G mm	Art.-Nr. / Order no.
526	2	18	112	60°	7	M22x1,5	● 03-526
536	3	24,1	137	60°	11	M27x1,5	● 03-536
546	4	31,6	175	60°	14	M36x1,5	● 03-546
556	5	44,7	217	60°	18	M48x1,5	● 03-556
566	6	63,8	290	60°	18	M68x1,5	● 03-566

Typ 507 DIN 807 HE

Type 507 DIN 807 HE

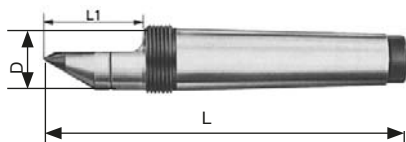

Hartmetalleinsatz, mit halber Spitze
mit Abdrückgewinde
Half carbide tip with thread

Typ / Type	MK / MT	D mm	L mm	Winkel / Angle	d mm	L1 mm	G mm	Art.-Nr. / Order no.
527	2	18	112	60°	7	30	M22x1,5	✘ 03-527
537	3	24,1	137	60°	11	38	M27x1,5	✘ 03-537
547	4	31,6	175	60°	14	50	M36x1,5	✘ 03-547
557	5	44,7	217	60°	18	63	M48x1,5	✘ 03-557
567	6	63,8	290	60°	18	79	M68x1,5	✘ 03-567

Typ 508 DIN 807 WS

Type 508 DIN 807 WS

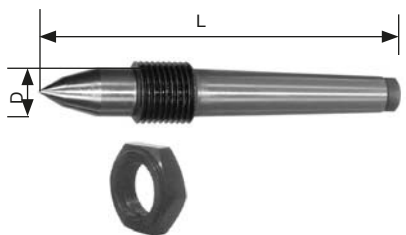

Verlängerte Spitze mit Abdrückmutter
Extended tip with draw-off nut

Typ / Type	MK / MT	D mm	L mm	Winkel / Angle	G mm	Art.-Nr. / Order no.
518	1	12,2	80	30°/60°	M16x1,5	✘ 03-518
528	2	18	118	30°/60°	M22x1,5	● 03-528
538	3	24,1	148	30°/60°	M27x1,5	● 03-538
548	4	31,6	186,5	30°/60°	M36x1,5	● 03-548
558	5	44,7	242	30°/60°	M48x1,5	● 03-558
568	6	63,8	330	30°/60°	M68x1,5	✘ 03-568

Passende Abdrückmuttern siehe Seite 123
Suitable draw-off nuts see page 123

Stirnmitnehmer, mechanisch

Mechanical face drivers

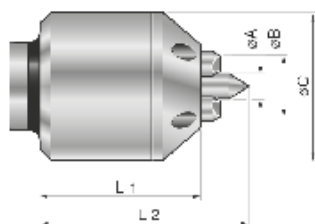

Lieferumfang:
Stirnmitnehmer, 1 Satz Mitnehmerbolzen S1,
1 Stück Zentrierspitze S4

Scope of supply:
Mechanical face driver, 1 set inserts S1,
1 piece centre S4

Typ A (19,3-32 mm)

Type A (19,3-32 mm)

Art.-Nr. /
Order no.

03-EA-S?

Beispiel / Ordering example
= 03-EA-S1

MK / MT	Ø Min. mm	Ø Max. mm	Ø A mm	Ø B mm	Ø C mm	L1 mm	L2 mm	kg	Art.-Nr. / Order no.
3	19,3	32	8	20	48	52	67	0,9	03-SMN-3/25
4	19,3	32	8	20	48	52	67	1,2	03-SMN-4/25



Typ B (30-47 mm)

Type B (30-47 mm)

Art.-Nr. /
Order no.

03-EB-S?

Beispiel / Ordering example
= 03-EB-S1

MK / MT	Ø Min. mm	Ø Max. mm	Ø A mm	Ø B mm	Ø C mm	L1 mm	L2 mm	kg	Art.-Nr. / Order no.
3	30	47	12	30	62	64	86	1,5	03-SMN-3/47
4	30	47	12	30	62	64	86	2,7	03-SMN-4/47
5	30	47	12	30	62	64	86	3,9	03-SMN-5/47



Typ C (40-70 mm)

Type C (40-70 mm)

Art.-Nr. /
Order no.

03-EC-S?

Beispiel / Ordering example
= 03-EC-S1

MK / MT	Ø Min. mm	Ø Max. mm	Ø A mm	Ø B mm	Ø C mm	L1 mm	L2 mm	kg	Art.-Nr. / Order no.
4	40	70	18	41	87	95	125	4,3	03-SMN-4/70
5	40	70	18	41	87	95	125	5,3	03-SMN-5/70
6	40	70	18	41	87	95	125	7,8	03-SMN-6/70

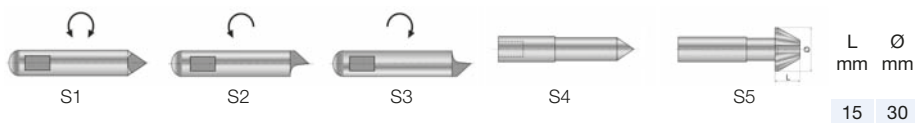

Typ D (57-90 mm)

Type D (57-90 mm)

Art.-Nr. /
Order no.

03-ED-S?

Beispiel / Ordering example
= 03-ED-S1

MK / MT	Ø Min. mm	Ø Max. mm	Ø A mm	Ø B mm	Ø C mm	L1 mm	L2 mm	kg	Art.-Nr. / Order no.
4	57	90	23	57	109	100	140	7,0	03-SMN-4/90
5	57	90	23	57	109	100	140	8,2	03-SMN-5/90
6	57	90	23	57	109	100	140	9,5	03-SMN-6/90

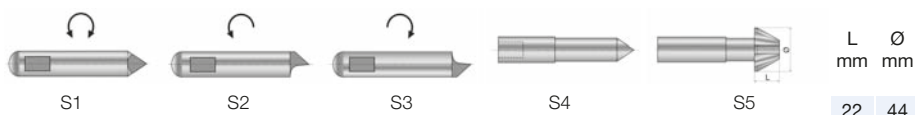

Kegelhülsen Conic bushes

Kegelhülsen, zylindrisch mit Innenkegel (MK) Conic bushes, cylindrical with internal taper (MT)

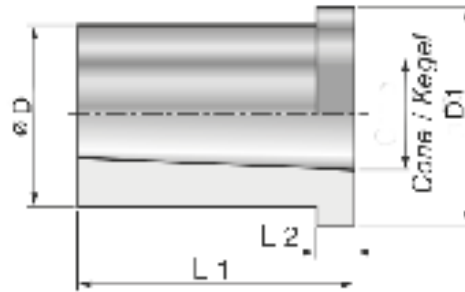
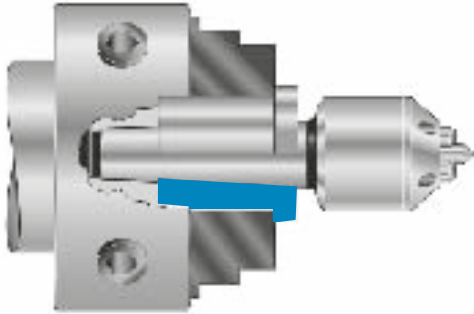

MK / MT	L1 mm	L2 mm	Ø D mm	D1 mm	kg	Art.-Nr. / Order no.
3	65	8	35	44	0,3	▶ 03-KH-3
4	70	8	42	49	0,45	▶ 03-KH-4
5	80	10	54	59	0,6	▶ 03-KH-5
6	85	10	75	84	0,75	▶ 03-KH-6

