

Zubehör

Accessories



■ Inhalt:

13.1 | Zubehör für Drehfutter und Planscheiben

- | Sicherheits- Dreh- und Schleifmitnehmer
- | Hohlspindelanschläge

13.2 | Zubehör für Schraubstöcke

- | Passsteine
- | Universal-Werkstückanschlag
- | Universal-Werkstückanschlag mit Magnet

13.3 | Zubehör für Steilkegelaufnahmen

- | Kegelwischer
- | Fräsdornringe
- | Schlüssel
- | Fräseranzugsschrauben
- | Austreiblappen
- | Überwurfmuttern
- | Mitnehmerringe
- | Passfedern
- | Spannschrauben für Weldon Futter
- | Austreiber
- | Schraubquerkeile
- | Kühlmittelröhrchen
- | Werkzeug-Regale
- | Werkzeugwagen
- | Montagehilfen

■ Content:

13.1 | Accessories for lathe and independent chucks

- | Safety driving rings
- | Hollow spindle stops

13.2 | Accessories for vices

- | Tee nuts
- | Stop dog
- | Universal work piece stop with magnet

13.3 | Accessories for SK-tooling

- | Taper cleaners
- | Spacing collars
- | Spanners
- | Cross retaining screws
- | Tangs
- | Clamping nuts
- | Clutch drive rings
- | Feather keys
- | Clamping screws for Weldon chucks
- | Ejectors
- | Driving tenons
- | Coolant tubes
- | Tool racks
- | Tooling trolleys
- | Assembly supports

Sicherheits- Dreh- und Schleifmitnehmer Safety drive rings



- Nachfolger des nicht mehr zulässigen Drehherzes
- Keine Unfallgefahr, da keine hervorstehenden Teile
- Eingestellter Spanndurchmesser wird beibehalten
- Zweiteilig - kann auch bei eingespanntem Werkstück angebracht werden
- No risk of injuries since free from protruding elements
- Adjusted clamping diameter is maintained
- Split design to allow mounting while work-piece is clamped

Größe / Size	Spannbereich / Clamping range mm	Art.-Nr. / Order no.
1	10-40	● 00-SM-1
2	40-70	● 00-SM-2
3	70-100	● 00-SM-3
4	100-150	○ 00-SM-4
5	150-200	○ 00-SM-5
6	200-250	○ 00-SM-6

Hohlspindelanschlüsse Hollow spindle stops



Optimales Hilfswerkzeug passend für nahezu jede Drehbank. Lohnend schon ab Kleinstserien. Teure Rüstzeiten können auf ein Minimum reduziert werden. Problemlos und schnell an jeder Stelle der Hohlspindel zu fixieren. Durch Anziehen mit dem mitgelieferten Schlüssel werden die integrierten Spannbacken an die Innenwand gepresst und gewährleisten so einen sicheren Sitz.

Useful auxiliary tool suitable for almost every lathe. Worthwhile even for small series production. Expensive set-up time can be reduced to a minimum. Quick and easy fixing at any position of the hollow spindle. By tightening with the enclosed key the integrated jaws are pressed against the spindle so that a secure seat is guaranteed.



Spindel-Ø / Spindle-Ø	Art.-Nr. / Order no.
20-27	● 83-322327
25-33	● 83-332731
32-41	● 83-343139
40-50	● 83-353947
48-60	● 83-364757
58-76	● 83-386578
75-96	● 83-397894
94-110	● 83-31094110

Ersatz O-Ringe auf Anfrage / Spare O-Rings upon request

Passteine, Paar Tee nuts, set of 2 pieces

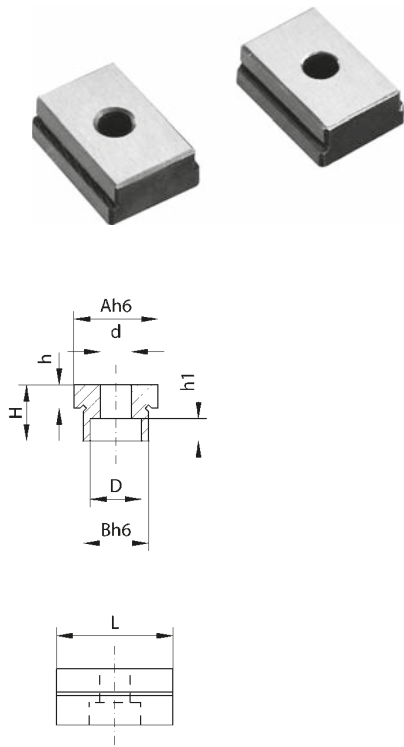

A mm	B mm	L mm	H mm	h mm	h1 mm	D mm	d mm	Art.-Nr. / Order no.
12	12	25	10	4,8	5,7	10	6	14-12-12
14	14	25	10	0	5,7	10	6	14-14-14
	18			4,8				14-14-18
	20			4,8				14-14-20
	22			4,8				14-14-22
16	12	25	10	4,8	5,7	10	6	14-16-12
	14			4,8				14-16-14
	16			0				14-16-16
	18			4,8				14-16-18
	20			4,8				14-16-20
	22			4,8				14-16-22
	24			4,8				14-16-24
	28			4,8				14-16-28
36	4,8	14-16-36						
18	12	25	10	4,8	5,7	10	6	14-18-12
	14			4,8				14-18-14
	16			4,8				14-18-16
	18			0				14-18-18
	20			4,8				14-18-20
	22			4,8				14-18-22
20	12	25	10	4,8	5,7	10	6	14-20-12
	14			4,8				14-20-14
	16			4,8				14-20-16
	18			4,8				14-20-18
	20			0				14-20-20
	22			4,8				14-20-22
22	14	25	10	4,8	5,7	10	6	14-22-14
	16			4,8				14-22-16
	18			4,8				14-22-18
	20			4,8				14-22-20
	22			0				14-22-22

Preis pro Paar / Price per set

Universal-Werkstückanschlag Universal stop-dog



- Universal-Werkstückanschlag aus zweifarbig eloxiertem Aluminium für Bohr- und Fräsmaschinen
- durch die zwei Gelenkpfannen und den 360° drehbaren Kopf ist jede Einstell-Lage möglich
- inkl. Nutenstein (für 16, 18 und 20 mm T-Nuten), Anschlagstange und Inbusschlüssel
- universal two-coloured work piece stop made from anodized aluminium for boring and milling machines
- two cranks and a knob (360° pivotable) allow any setting angle
- incl. t-nut (for 16, 18 and 20 mm), stop rod and hexagon wrench

Höhe Anschlagst. / Height of stop rod mm	Gesamthöhe / Total height mm	Anschlagst.-Ø / Stop rod dia. mm	Art.-Nr. / Order no.
155	215	8	09-AMS-160BH

Universal-Werkstückanschlag mit Magnet Universal work piece stop with magnet



- passend für alle Schraubstöcke
- keine Gewindebohrungen nötig
- suitable for all types of vices
- no threads required

Gesamthöhe / Total height mm	Länge der Anschlagstange / Length of stop rod mm	Anschlagst.-Ø / Stop rod-Ø mm	Art.-Nr. / Order no.
100	125	6	09-WAM

Lagerstandard / in stock
innerhalb weniger Tage / within a few days
auf Anfrage / on request
auslaufende Größe / as stock lasts

Kegelwischer Taper cleaners



SK

- Material: Holz

- material: wood

Größe / Size	Art.-Nr. / Order no.
SK 30	09-76200030
SK 40	09-76200040
SK 45	09-76200045
SK 50	09-76200050
SK 60	09-76200060



MK / MT

- Material: Holz

- material: wood

Größe / Size	Art.-Nr. / Order no.
MK 1	09-76200001
MK 2	09-76200002
MK 3	09-76200003
MK 4	09-76200004
MK 5	09-76200005
MK 6	09-76200006



HSK

- Material: Kunststoff
- passend für Form A / C / E

- material: plastic
- suitable for form A / C / E

Größe / Size	Art.-Nr. / Order no.
HSK 32	09-76205032
HSK 40	09-76205040
HSK 50	09-76205050
HSK 63	09-76205063
HSK 80	09-76205080
HSK 100	09-762050100



ER

- Material: Holz

- material: wood

Größe / Size	Art.-Nr. / Order no.
ER 16	09-76202016
ER 20	09-76202020
ER 25	09-76202025
ER 32	09-76202032
ER 40	09-76202040



OZ

- Material: Holz

- material: wood

Größe / Size	Art.-Nr. / Order no.
OZ 16 (415E / 410E)	09-76203016
OZ 25 (462E / 444E)	09-76203025
OZ 32 (467E / 450E)	09-76203032

- Lagerstandard / in stock
- ▶ innerhalb weniger Tage / within a few days
- auf Anfrage / on request
- ✱ auslaufende Größe / as stock lasts



Fräsdornringe DIN 2084 A Spacing collars DIN 2084 A



Form A

Aus federhartem Spezialstahl gestanz
und entgratet.

*From punched spring steel, deburred
edges.*

Bohr-Ø / Bore-Ø	16	22	27	32	40	50	60
Außen-Ø / External-Ø	25	33	39	45	54	67	83
Stärke / Thickness mm							
0,03							
0,04							
0,05							
0,10							
0,20							
0,30							
0,40							
0,50							
0,60							
1,00							

Weitere Größen auf Anfrage
Further sizes available upon
request

Art.-Nr.
Order no.

Beispiel / Ordering example: 27 x 0,03 = 09-2084A27003

09-2084AØ

Der Preis versteht sich pro Stück.
Price is per piece.

Fräsdornringe DIN 2084 B Spacing collars DIN 2084 B



Form B

Aus Stahl gedreht, gehärtet, planparallel
geschliffen und geläppt.

*Turned from steel, hardened, ground and
lapped.*

Bohr-Ø / Bore-Ø	13	16	22	27	32	40	50	60
Außen-Ø / External-Ø	22	27	34	41	47	55	69	83
Stärke / Thickness mm								
1								
2								
3								
4								
5								
6								
10								
20								
30								
60								
100								

Weitere Größen und Endringe
auf Anfrage
Further sizes and end rings
available upon request

Art.-Nr.
Order no.

Beispiel / Ordering example: 16 x 1 = 09-2084B161

09-2084BØ

Der Preis versteht sich pro Stück.
Price is per piece.

Lagerstandard / in stock
innerhalb weniger Tage / within a few days
auf Anfrage / on request
auslaufende Größe / as stock lasts



Fräsdornringe DIN 2084 B

Spacing collars DIN 2084 B

Fräsdornringe-Sortiment

Spacing collar sets



- Lieferung erfolgt in Kunststofftasche - delivered in plastic case

Sortiment / Set	Bohrung / Bore mm	Inhalt / Contents	Art.-Nr. / Order no.
1	16	60	● 09-2084A16S1
1	22	60	● 09-2084A22S1
1	27	60	● 09-2084A27S1
1	32	60	● 09-2084A32S1
1	40	60	● 09-2084A40S1
2	16	35	● 09-2084A16S2
2	22	35	● 09-2084A22S2
2	27	35	● 09-2084A27S2
2	32	35	● 09-2084A32S2
2	40	35	● 09-2084A40S2

Sortiment / Set	0,03	0,04	0,05	0,1	0,2	0,3	0,5	0,6	1,0	1,5
1	10	10	10	10	5	5	4	3	2	1
2	5	5	5	6	3	3	3	2	2	1

13
133

Zubehör für Steilkegelaufnahmen / Accessories for SK tooling



Schlüssel Spanners



Sicherheitsschlüssel ER Mini Safety-spanners ER Mini

Größe / Size	Art.-Nr. / Order no.
ER 8 M	09-SCH-ER8M
ER 11 M	09-SCH-ER11M
ER 16 M	09-SCH-ER16M
ER 20 M	09-SCH-ER20M
ER 25 M	09-SCH-ER25M



Sicherheitsschlüssel ER Safety-spanners ER

Größe / Size	Art.-Nr. / Order no.
ER 16	09-SCH-ER16
ER 20	09-SCH-ER20
ER 25	09-SCH-ER25
ER 32	09-SCH-ER32
ER 40	09-SCH-ER40
ER 50	09-SCH-ER50



Hakenschlüssel OZ Hook wrenches OZ

Für SZ / For collet	Ø mm	Art.-Nr. / Order no.
415 E (OZ 16)	43	09-SCH-OZ16
462 E (OZ 25)	60	09-SCH-OZ25
467 E (OZ 32)	72	09-SCH-OZ32
468 E (OZ 40)	82	09-SCH-OZ40

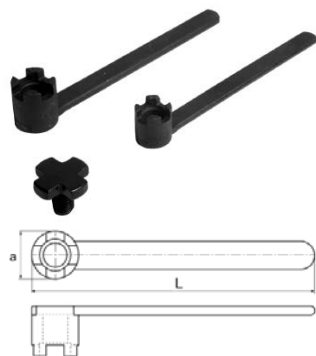

Schlüssel für Fräseranzugsschrauben DIN 6368 Spanners for cross screws DIN 6368

Ø Fräsdorn / Ø Arbor	L mm	Art.-Nr. / Order no.
13	160	09-SCH-KD13
16	180	09-SCH-KD16
22	200	09-SCH-KD22
27	225	09-SCH-KD27
32	250	09-SCH-KD32
40	280	09-SCH-KD40
50	315	09-SCH-KD50

Fräseranzugsschrauben Cross retaining screws

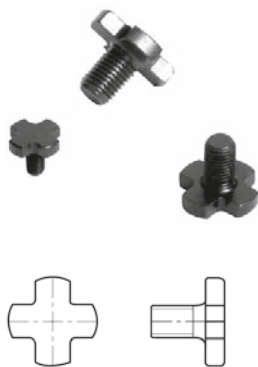

Für Fräsdorne DIN 6367 For shell end mill holders DIN 6367

Ø Fräsdorn / Ø Arbor	Gewinde / Thread	Art.-Nr. / Order no.
13	M6	● 09-VTC-M6
16	M8	● 09-VTC-M8
22	M10	● 09-VTC-M10
27	M12	● 09-VTC-M12
32	M16	● 09-VTC-M16
40	M20	● 09-VTC-M20

Für Fräsdorne DIN 6367 mit innerer Kühlmittelzufuhr For shell end mill holders DIN 6367 with IC

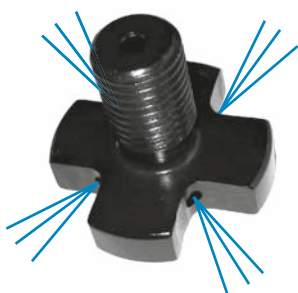

Ø Fräsdorn / Ø Arbor	Gewinde / Thread	Art.-Nr. / Order no.
16	M8	● 09-VTCIK-M8
22	M10	● 09-VTCIK-M10
27	M12	● 09-VTCIK-M12
32	M16	● 09-VTCIK-M16
40	M20	● 09-VTCIK-M20

Austreibblappen Tangs



Einschraubbare Austreibblappen für Morsekegel Removable tangs for morse taper shanks

Größe / Size	Gewinde / Thread	Art.-Nr. / Order no.
MK 1	M6	● 09-ATL-MK1
MK 2	M10	● 09-ATL-MK2
MK 3	M12	● 09-ATL-MK3
MK 4	M16	● 09-ATL-MK4
MK 5	M20	● 09-ATL-MK5

Überwurfmuttern OZ Standard clamping nuts OZ

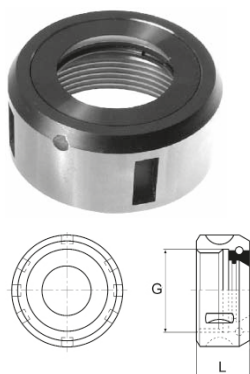

Kugellagert With roller-bearing

Für SZ / For collet	G	L mm	Art.-Nr. / Order no.
OZ 16 (415E)	M33 x 1,5	24	● 09-GOC-16
OZ 20 (4541E)	M42 x 2	28	● 09-GOC-20
OZ 25 (462E)	M48 x 2	30	● 09-GOC-25
OZ 32 (467E)	M60 x 2,5	33,5	● 09-GOC-32
OZ 40 (468E)	M68 x 2,5	37	● 09-GOC-40

Überwurfmutter ER Clamping nuts ER

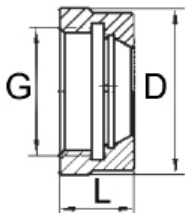
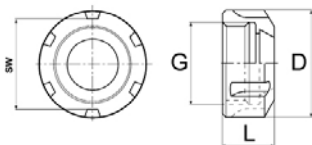
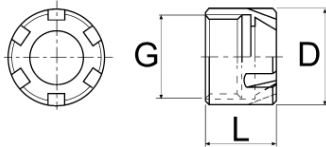

Mitnehmerringe Clutch drive rings

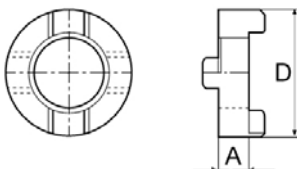

Mini Mini

Für SZ / For collet	G mm	D mm	L mm	Art.-Nr. / Order no.
ER 8	M10 x 0,75	12	10,8	● 09-G-8M
ER 11	M13 x 0,75	16	12	● 09-G-11M
ER 16	M19 x 1	22	18	● 09-G-16M
ER 20	M24 x 1	28	19	● 09-G-20M
ER 25	M30 x 1	35	20	● 09-G-25M

Standard Standard

Für SZ / For collet	G mm	D mm	L mm	SW	Art.-Nr. / Order no.
ER 16	M22 x 1,5	32	17	27	● 09-UM-ER16
ER 20	M25 x 1,5	35	18,5	30	● 09-UM-ER20
ER 25	M32 x 1,5	42	20	37	● 09-UM-ER25
ER 32	M40 x 1,5	50	22,5	45	● 09-UM-ER32
ER 40	M50 x 1,5	63	25,5	58	● 09-UM-ER40
ER 50	M64 x 2,0	78	35,5	72	● 09-UM-ER50

Sechskant Hexagonal

Für SZ / For collet	G mm	D mm	L mm	SW	Art.-Nr. / Order no.
ER 16	M22 x 1,5	28	17,5	25	● 09-UM-ER16H
ER 20	M25 x 1,5	34	19	30	● 09-UM-ER20H

Für Fräsdorne DIN 6366 For combination end mill holders DIN 6366

Ø Fräsdorn / Ø Arbor	D mm	A mm	Art.-Nr. / Order no.
D13	28	10	● 09-ATR-D13
D16	32	10	● 09-ATR-D16
D22	40	12	● 09-ATR-D22
D27	48	12	● 09-ATR-D27
D32	58	14	● 09-ATR-D32
D40	70	14	● 09-ATR-D40
D50	90	16	* 09-ATR-D50



Passfedern Feather keys



Für Kombi-Fräseraufsteckdorne For combination end mill adaptors

- mit Abdrückschraube

- with push-off screw

H mm	B mm	L mm	Schraube / Screw	Art.-Nr. / Order no.
4	4	20	M2 x 4	● 09-PAF-M2/4
6	6	25	M3 x 5	● 09-PAF-M3/6
7	7	25	M3 x 6	● 09-PAF-M3/7
8	7	28	M3 x 6	● 09-PAF-M3/8
10	8	32	M3 x 6	● 09-PAF-M3/10

Spannschrauben Clamping screw



Für Weldon Spannfutter, DIN 1835B For Weldon chucks, DIN 1835B

Für Ø / For Ø mm	Gewinde / Thread mm	L mm	Art.-Nr. / Order no.
6	M6	10	● 09-WSS-M6/10
8	M8	10	● 09-WSS-M8/10
10	M10	12	● 09-WSS-M10/12
12-14	M12	16	● 09-WSS-M12/16
16-18	M14	16	● 09-WSS-M14/16
20	M16	16	● 09-WSS-M16/16
25	M18 x 2	20	● 09-WSS-M18/20
32-40	M20 x 2	20	● 09-WSS-M20/20

Austreiber Ejectors



Größe / Size	L mm	Art.-Nr. / Order no.
MK 0	90	01-2000
MK 1+2	140	01-2002
MK 3	190	01-2003
MK 4	225	01-2004
MK 5+6	265	01-2005

Halbautomatische Austreiber Half automatic ejectors



- Einhandbedienung
- Vermeidung von Spindelbeschädigungen beim Lösen der Werkzeuge
- *single-hand operation*
- *no risk of damage to the spindle when removing the tools*

Größe / Size	Länge / Length mm	Art.-Nr. / Order no.
MK 1+2+3	317	01-8003
MK 4+5+6	380	01-8006

Schraubquerkeile Driving tenons

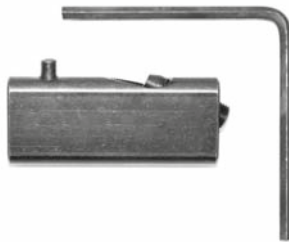

- zum Spannen von Kegelschäften mit Mitnehmerlappen und Querkeilschlitz
- große Sicherheit durch festen Sitz
- schnelles Spannen und Lösen mit einer Schraube
- Schonung der Spindellager
- *secure clamping of taper shanks with tenons and driving slots*
- *higher safety thanks to tight fit*
- *fast clamping and removing with one screw*
- *less impact on spindle bearings*

MK / MT	Für Spindel-Ø / For spindle-Ø mm	Art.-Nr. / Order no.
3	36	09-SQ-3-36
4	48	09-SQ-4-48
4	63	09-SQ-4-63
5	63	09-SQ-5-63
5	80	09-SQ-5-80
6	100	09-SQ-6-100

Kühlmittelröhrchen Coolant tubes



Für / For	D mm	G mm	Art.-Nr. / Order no.
HSK 32	6	M10x1	17-KMR32
HSK 40	8	M12x1	17-KMR40
HSK 50	10	M16x1	17-KMR50
HSK 63	12	M18x1	17-KMR63
HSK 80	14	M20x1,5	17-KMR80
HSK 100	16	M24x1,5	17-KMR100

Werkzeug-Regale Tool racks



Werkzeugregale 3-stufig, Typ WR3K2 Tool racks 3-staged, type WR3K2

- inkl. Einsätze
- passend für alle Einsätze
- incl. inserts
- suitable for all types of inserts

Kegelgröße / Shank size	Plätze / Tool seats	Art.-Nr. / Order no.
SK 30 / BT 30	24	● WZ-WR3K2-SK30
SK 40 / BT 40	21	● WZ-WR3K2-SK40
SK 50 / BT 50	15	● WZ-WR3K2-SK50
HSK 63	18	● WZ-WR3K2-HSK63

Werkzeugregale 1-stufig, Typ WRS2 Tool racks 1-staged, type WRS2



- inkl. Einsätze
- modulares System
- passend für alle Einsätze
- incl. inserts
- modular system
- suitable for all types of inserts

Kegelgröße / Shank size	Plätze / Tool seats	Art.-Nr. / Order no.
SK 30 / BT 30	8	● WZ-WRS2-SK30
SK 40 / BT 40	7	● WZ-WRS2-SK40
SK 50 / BT 50	6	● WZ-WRS2-SK50
HSK 63	6	● WZ-WRS2-HSK63

Werkzeugregaleinsätze Tool rack inserts



Kegelgröße / Shank size	Art.-Nr. / Order no.
SK 30 / BT 30	● WZ-RE2-SK30
SK 40 / BT 40	● WZ-RE2-SK40
SK 50 / BT 50	● WZ-RE2-SK50
HSK 63	● WZ-RE2-HSK63

Werkzeugwagen Tooling trolleys



Werkzeugwagen Tooling trolley

- Maße: 1.002 x 650 x 810 mm
- Lieferung erfolgt unmontiert
- inkl. Einsätze
- dimensions: 1.002 x 650 x 810 mm
- delivery unmounted
- incl. inserts

Kegelgröße / Shank size	Plätze / Tool seats	kg	Art.-Nr. / Order no.
SK 30 / BT 30	32	51	● WZ-WW-SK30
SK 40 / BT 40	28	51	● WZ-WW-SK40
SK 50 / BT 50	20	51	● WZ-WW-SK50
HSK 63	24	51	● WZ-WW-HSK63

- Lagerstandard / in stock
- ▶ innerhalb weniger Tage / within a few days
- auf Anfrage / on request
- * auslaufende Größe / as stock lasts

Montagehilfen Assembly supports



Montagehilfe, Aluminium Assembly support, aluminium

A mm	B mm	Für / For	Art.-Nr. / Order no.
80	75	ISO-DIN-CAT-BT30	09-TAL30
90	85	ISO-DIN-CAT-BT40	09-TAL40
120	115	ISO-DIN-CAT-BT50	09-TAL50

Montageblock, schwenkbar Assembly support, tiltable

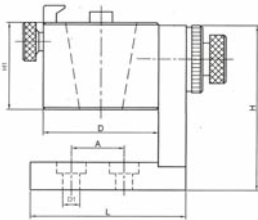

Größe / Size	D mm	H1 mm	D1 mm	H mm	A mm	L mm	Art.-Nr. / Order no.
SK 30 / BT 30	88	50	11	132	55	111	47-MBSK-30
SK 40 / BT 40	93	57	11	132	55	111	47-MBSK-40
SK 50 / BT 50	118	62	11	176	55	111	47-MBSK-50
VDI 16	78	50	11	132	55	111	47-MBS-16
VDI 20	83	50	11	132	55	111	47-MBS-20
VDI 25	93	57	11	132	55	111	47-MBS-25
VDI 30	93	57	11	132	55	111	47-MBS-30
VDI 40	102	57	11	132	55	111	47-MBS-40
VDI 50	118	62	11	132	55	111	47-MBS-50
HSK 40	88	50	11	132	55	111	47-MBHSK-40
HSK 50	93	57	11	132	55	111	47-MBHSK-50
HSK 63	98	57	11	132	55	111	47-MBHSK-63
HSK 100	135	62	11	132	55	111	47-MBHSK-100

Montageblock DIN / ISO / BT Assembly support DIN / ISO / BT

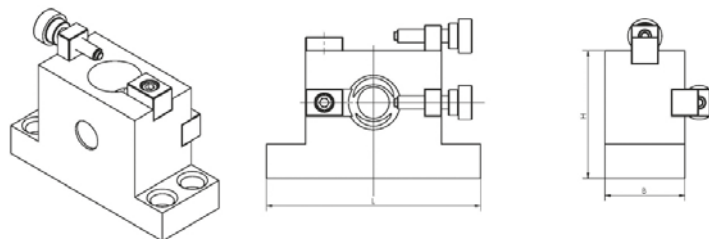

Größe / Size	H mm	B mm	L mm	Art.-Nr. / Order no.
SK 30 / BT 30	75	47	126	09-MBW-30
SK 40 / BT 40	104	63	161	09-MBW-40
SK 50 / BT 50	155	98	182	09-MBW-50

